



Memorial United Methodist Church

17821 Elgin Rd. / PO Box 358, Poolesville MD 20837

301-349-2010 | office@pmumc.org

www.PMUMC.org

Maundy Thursday
April 1, 2021 at 7 pm



MEMORIAL UNITED METHODIST CHURCH

Poolesville, MD



Thank you for coming together in worship this evening. As we gather, take time to relax and prepare your heart to listen for God through today's time of prayer, song, and scripture study. As you participate with heart and/or voice, the words will be displayed on your screen for your convenience.

UMH=United Methodist Hymnal; TFWS=The Faith We Sing.

Maundy Thursday Worship Service with Communion—April 1, 2021

MESSAGE - *\$100 Bill*

SCRIPTURES: 1 Corinthians 11:23-26 and John 13:1-17, 31b-35

CALL TO WORSHIP

LEADER: A table is set before us. A feast is prepared for us.
PEOPLE: **A meal of bread and wine, of meat and bitter herbs.**
LEADER: The Lord calls us to this supper of remembrance.
PEOPLE: **The Lord calls us to serve and to be served.**
LEADER: As we break the bread and share the cup,
PEOPLE: **our understanding may fail us.**
LEADER: But we will never forget Christ's example.
PEOPLE: **We will never forget the full extent of his love.**

OPENING PRAYER

Holy God, you put all power and authority into the hands of Jesus, who in turn used those hands to wash feet in humble service. Teach us to love one another as Christ has loved us, that through our example, all might come to know the love of Jesus; through whom we pray. Amen.

MUSIC

| | | |
|-------------|--|----------------------|
| PRE-SERVICE | <i>Ab, Holy Jesus</i> | by Michael Burkhardt |
| | <i>Jesus, Our Divine Companion</i> | by Robert Hebble |
| | <i>When Jesus Wept</i> | by Dennis Eliot |
| PRELUDE | <i>Bread of the World</i> (Piano/Organ Duet) | by Gilbert M. Martin |
| HYMNS | <i>What Wondrous Love is This</i> | UMH 292 |
| COMMUNION | <i>There Is a Fountain Filled with Blood</i> | by Don Hustad |
| POSTLUDE | <i>Jesus Paid It All</i> | by Hayes/Gaspard |

CONTRIBUTORS TO WORSHIP

| | |
|--|--|
| PASTOR: Rev. Timothy A. Dowell | WORSHIP ASST: Sandy Parnell-Dowell |
| LITURGISTS: Sandi Baggett, Ray Hoewing | ORGAN/PIANO: Linda Custer, Janet Hartz |
| VOCALISTS: Sandi Baggett, Laura Blauch, Link Hoewing, Wendy Huff, Tim Melton | |
| AUDIO/VIDIO: Tim Melton, Kevin Schramm | |

Whenever you **eat** this **bread** and
drink this **cup**, you proclaim the
Lord's **death** until He **comes**.

Find the words in the word search below.

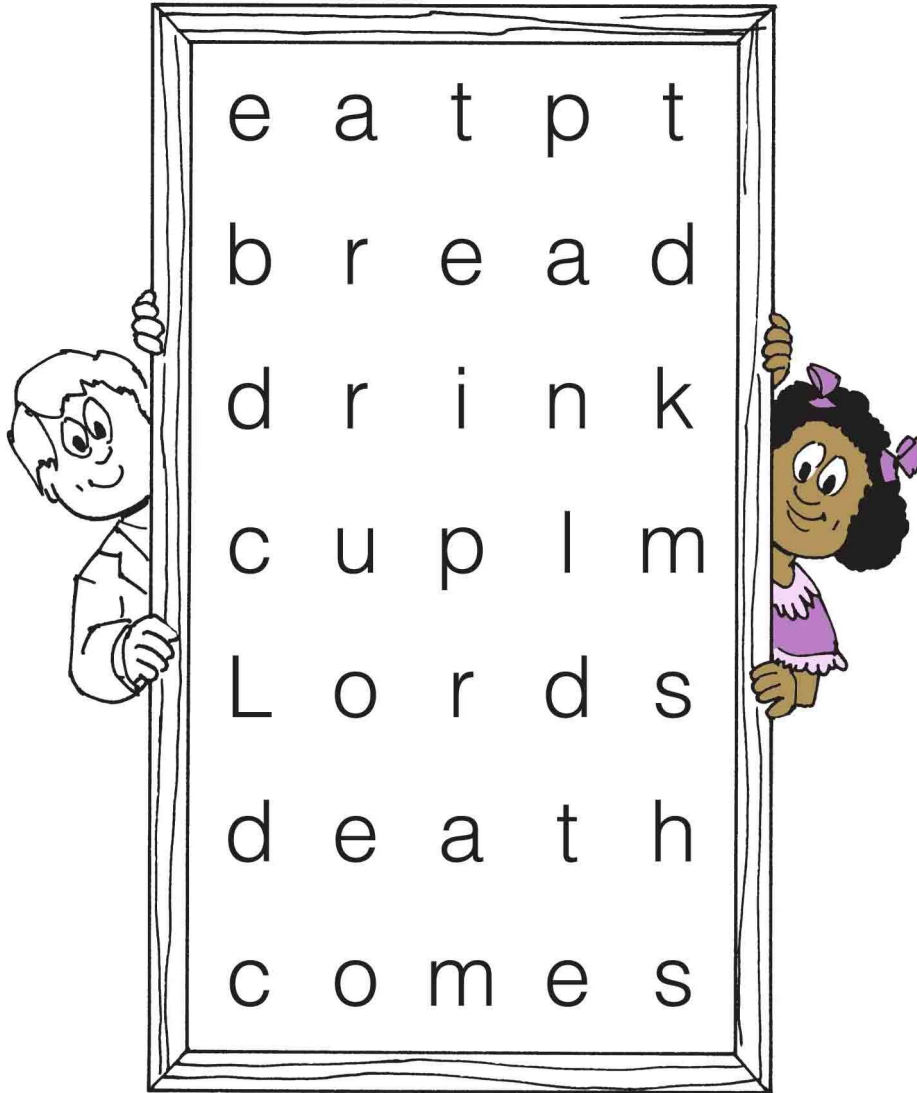





The Lord's Supper

It was night time when Jesus shared a last supper with His disciples.

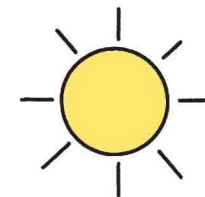
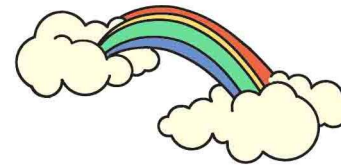

Circle the pictures that have to do with night.



The Lord Jesus ... took bread  ,
and when He had given thanks  ,
He broke it  and gave it to
His disciples  .

Match the pictures in order.

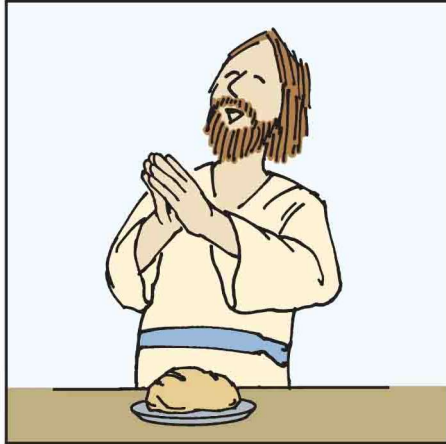

1

2

3

4

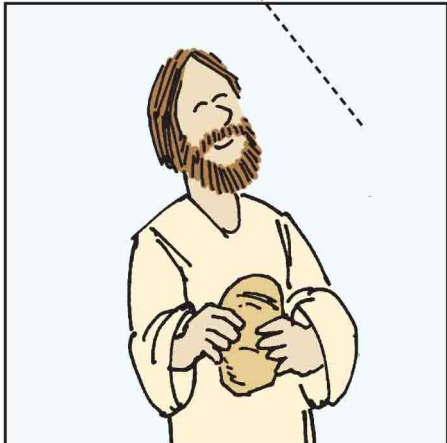

After supper, Jesus also took the ...

Trace the letters and finish the picture below.

CUP

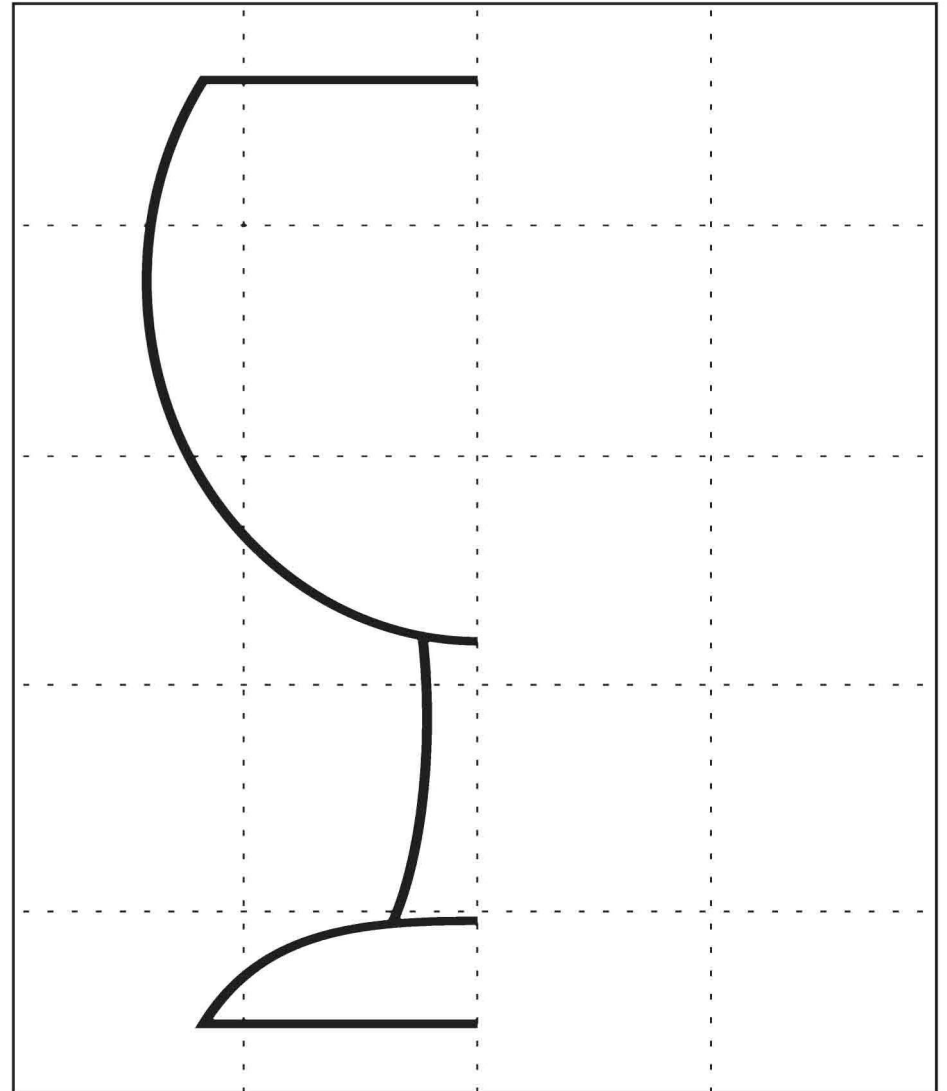

Love one another!

Circle the ways you can show love to others.

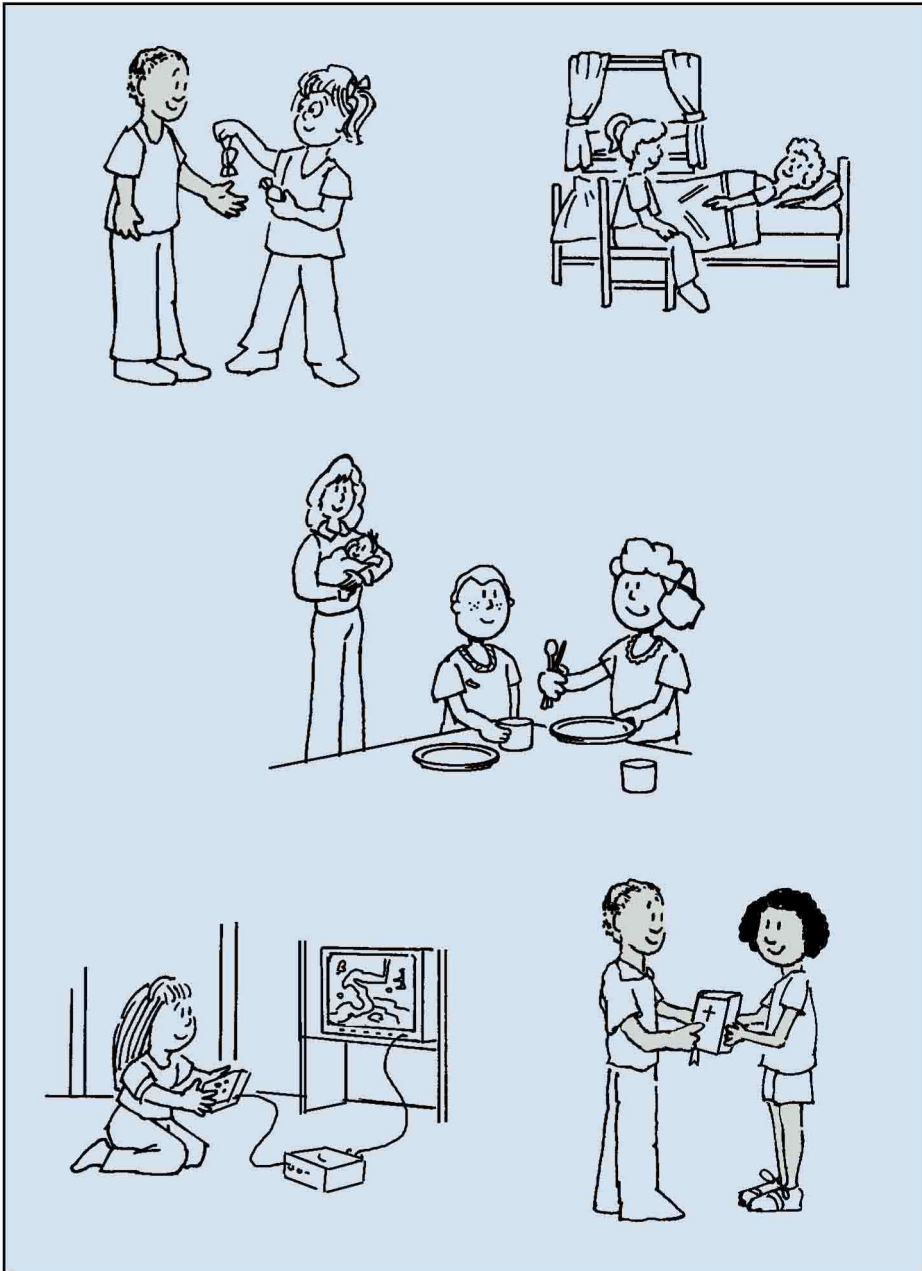

Children's Worship Bulletin™



Ages 3+

April 4, 2021 • John 13:1-17, 31-35

Jesus Washes His Disciples' Feet

Jesus poured water in a bowl. He began to wash the feet of His disciples.

Find the hidden objects in the picture.



Enter your **SECRET CODE** to unlock games @ games.childrensbulletins.com **SECRET CODE**
DMZC81

Why did Jesus wash their feet?

Use the code below to fill the missing letters in the puzzle below.

•=O ••=N •••=S ••••=H •••••=M

T _ _ _ W
 • •• ••• •

T _ _ E _ _ T _ _ E Y
 •• ••• •••

_ _ _ U L D
 •• ••• •

_ _ E R V E _ _ E
 •• • ••

A _ _ T _ _ E R .
 • • ••

Jesus said, "If you do as I have done, you will be blessed."

Match the shapes.

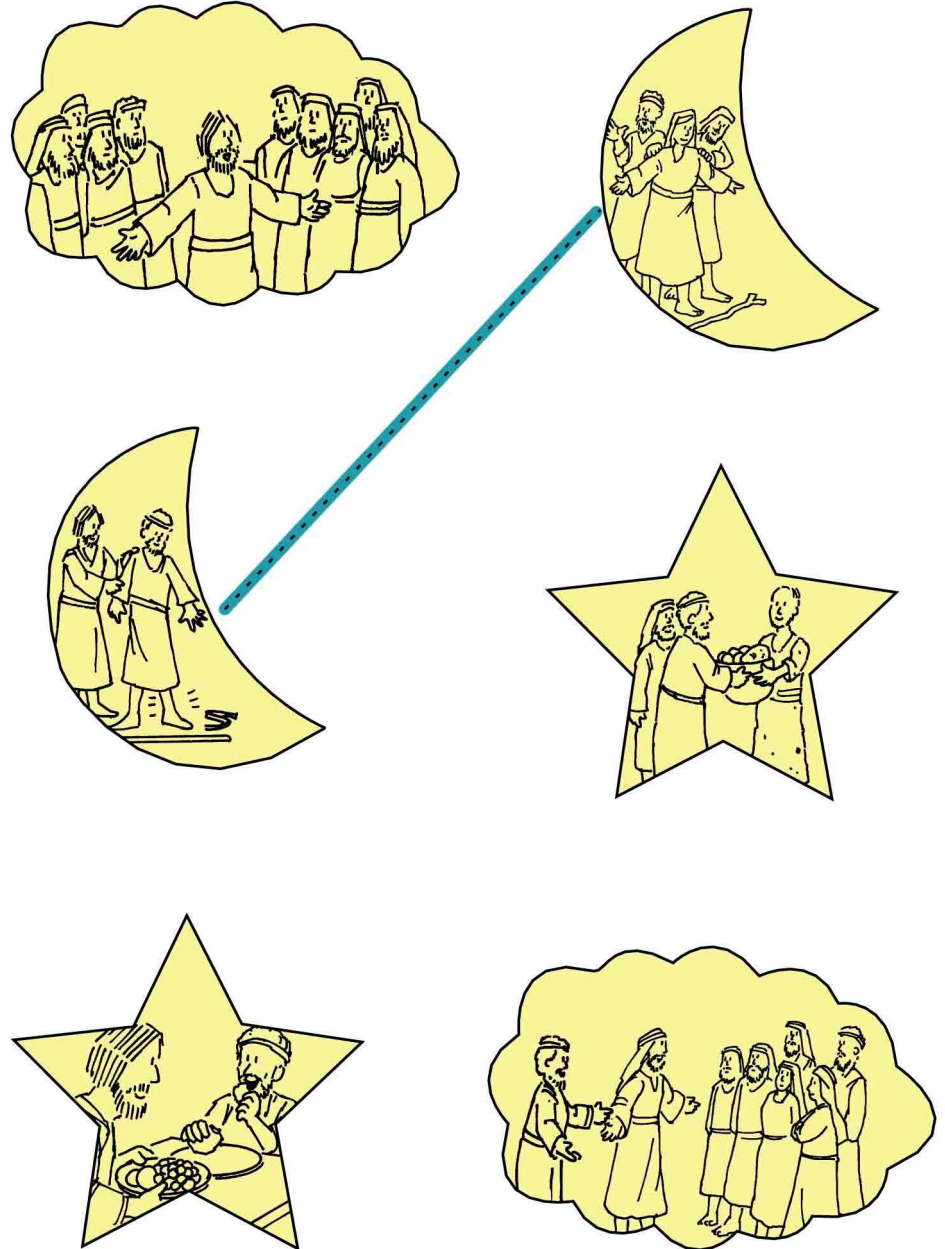

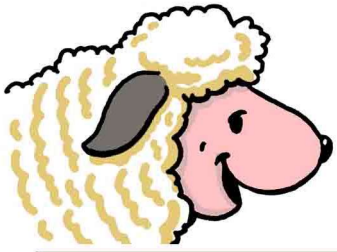

Jesus wants us always to remember Him.



Starting with W, follow the direction arrows through the grid to find Christ's message.

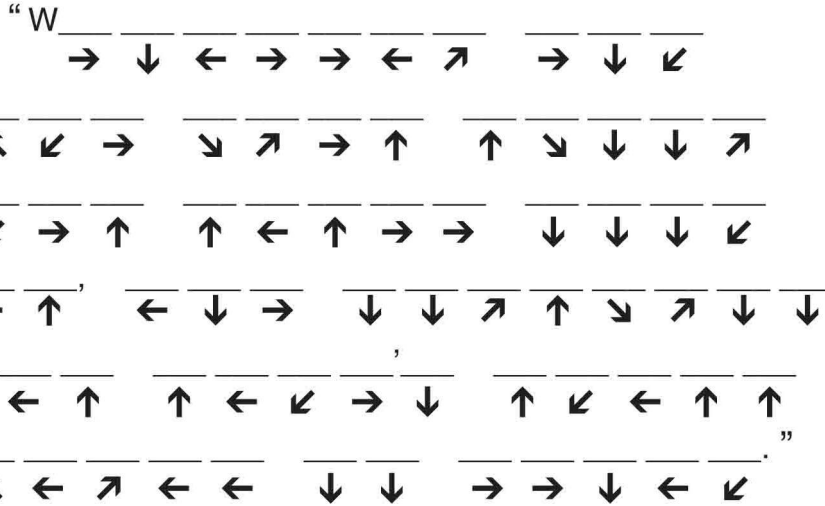
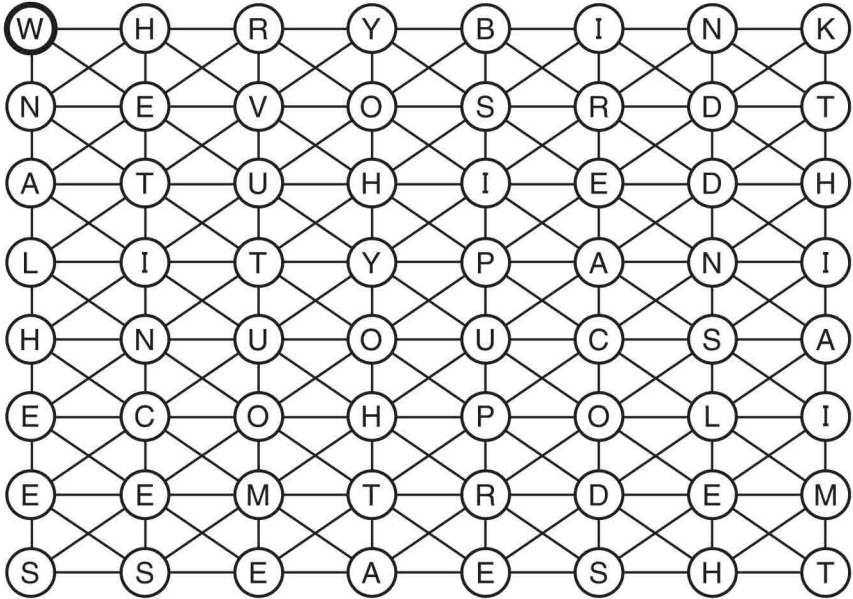

Children's Worship Bulletin™

Ages 7+

April 4, 2021 • 1 Corinthians 11:23-26

The Lord's Supper

Jesus ate the Passover dinner with His disciples the evening before He was crucified.

Find 6 things that are different in the second picture.

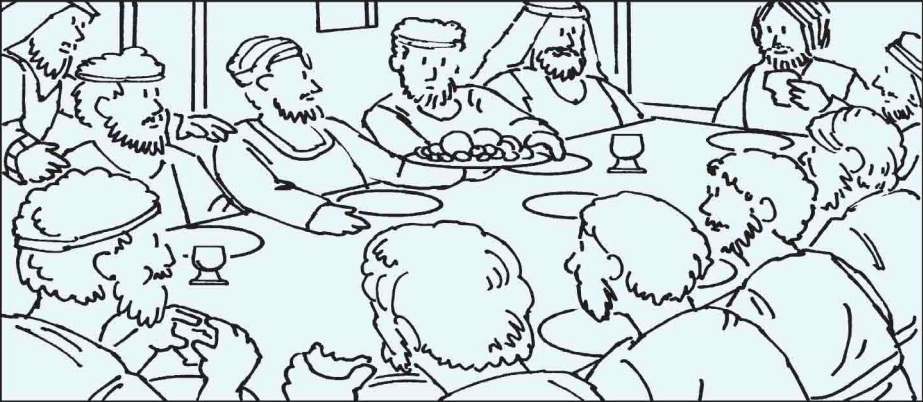
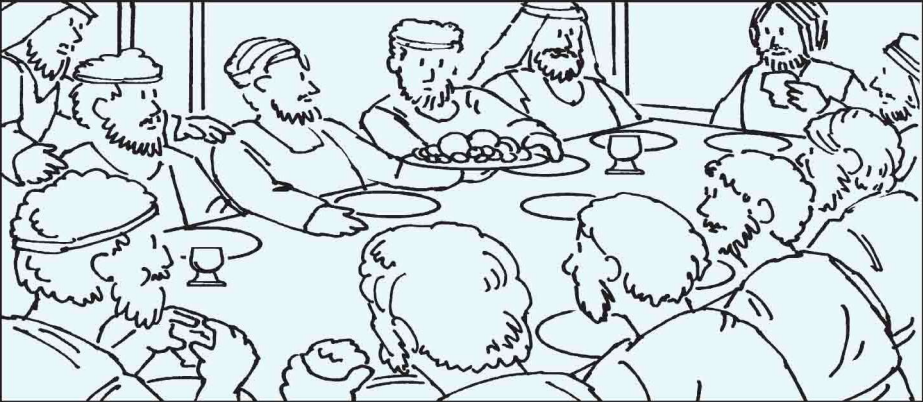

2 items in the meal had special significance.

Follow the directions to transform each item into what it meant.

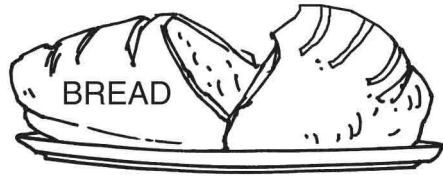

- 1) Move the R to make facial hair _____
- 2) Change E to O to make a piece of wood _____
- 3) Change AR to L to make courageous _____
- 4) Add LY at the end to tell how a hero behaves _____
- 5) Remove both L's _____

The _____ of Christ

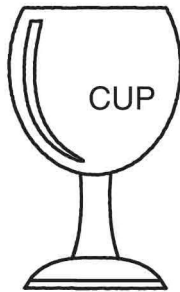

- 1) Change P to D to make something a cow chews _____
- 2) Change U to O to make a kind of fish _____
- 3) Change C to G to make the One we worship _____
- 4) Add an O to make the opposite of bad _____
- 5) Change the G to BL _____

The _____ of Christ



The bread and the cup were always to remind people about Jesus.



Find and cross out names of 14 foods that may have been on the Passover dinner table. Put the remaining letters in order into the blanks to complete Jesus' command.

| | | | | |
|-------|--------|--------|---------|------------|
| bread | fish | herbs | parsley | vegetables |
| eggs | grains | meat | salt | wine |
| figs | grapes | olives | soup | |

V P S O U P I F
 E A N L R E M I
 G R A I N S E S
 E S M V B R A H
 T L M E A T N C
 A E H S A L T E
 B Y E O F I G S
 L G R A P E S G
 E F B R E A D G
 S M S E W I N E

“ Do this _____

_____”



Jesus said to His disciples:

Change the letters to find Jesus' words.

B to I K to O Z to U
F to A P to E

" _ n _ w c _ m m _ n d
F P K F

_ g _ v _ y _ :
B B P K Z

L _ v _ _ n _ _ n _ t h _ r.
K P K P F K P

_ s _ h _ v _ l _ v _ d
F B F P K P

y _ , s _ y _ m _ s t
K Z K K Z Z

l _ v _ _ n _ _ n _ t h _ r."
K P K P F K P

Children's Worship Bulletin™

Ages 7+

April 4, 2021 • John 13:1-17, 31-35

Jesus Washes His Disciples' Feet

Jesus knew that the time had come for Him to leave the world and go to His Father. Jesus got up from the meal and wrapped a towel around His waist.

What did He do next?

Use this code to find out

| | | | | | | | | | | | | | | | | | | | | | | | | | |
|---|---|---|---|---|---|---|---|---|----|----|----|----|----|---|---|---|---|---|---|---|---|---|---|---|---|
| A | B | C | D | E | F | G | H | I | J | K | L | M | N | O | P | Q | R | S | T | U | V | W | X | Y | Z |
| 1 | 2 | 3 | 4 | 5 | 6 | 7 | 8 | 9 | 10 | 11 | 12 | 13 | 14 | | | | | | | | | | | | |

| | | | | | | | | | | | | |
|-----|-----|-----|-------|------|-------|-----|-----|----|-----|-------|---|------|
| 4,5 | 3 | 8,9 | 8 | 11 | 9,10 | 3 | 2,3 | 12 | 1 | 10,11 | 3 | 9,10 |
| 5 | 7,8 | 1 | 1,2 | 1 | 10 | 5 | 7,8 | 1 | 7,8 | 2,3 | | |
| 1,2 | 3 | 4 | 1 | 7,8 | 10,11 | 8 | 12 | 1 | 10 | 4,5 | | |
| 1 | 7,8 | 2,3 | 2,3 | 9,10 | 13 | 4,5 | 5 | 10 | | | | |
| 2,3 | 5 | 10 | 2 | 5 | 8,9 | 6,7 | 3 | 10 | | | | |
| 3,4 | 3 | 3 | 10,11 | | | | | | | | | |

Enter your **SECRET CODE** to unlock games @ games.childrensbulletins.com

SECRET CODE
WBG203

When Jesus finished, He returned to His place at the table. He asked the disciples if they understood what He had done.

Find the missing words by writing the letter on the line that's in the first word of the set, but not the second word.

earth/tear _____
 rude/red _____
 meal/ale _____
 bath/hat _____
 table/beat _____
 teach/chat _____

stable/bleat _____
 year/ray _____
 under/dune _____
 vest/set _____
 chain/inch _____
 rinse/sire _____
 water/wear _____

He was teaching them to be _____.

He acted as a _____ to them.

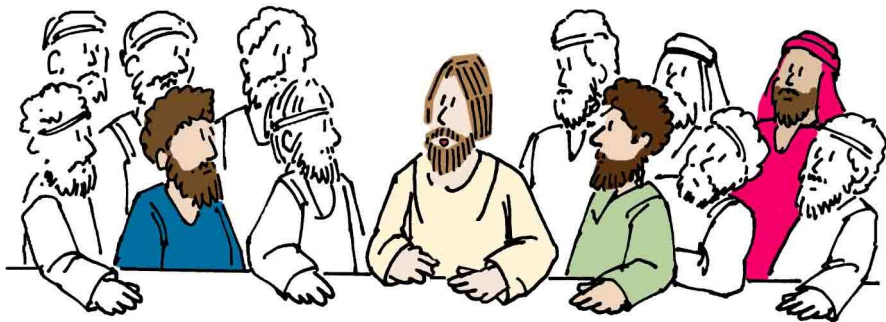

What did Jesus tell them next?

Follow the arrows from letter to letter.

